



Whynter 13.8 cu.ft. Energy Star Digital Upright Convertible Deep Freezer / Refrigerator - Stainless Steel

Model # : UDF-139SS

INSTRUCTION MANUAL



Congratulations on your new Whynter product. To ensure proper operation, please read this Instruction Manual carefully before using this product. Keep this manual in a safe place for future reference.

Table of Contents

	<u>PAGE</u>
Safety Precautions	3 - 4
Parts and Accessories	5
Product Features / Technical Data	6
Installation	7 - 8
Operation and Controls	9 - 11
Cleaning and Maintenance	12 - 13
Troubleshooting	14 - 15
Warranty Information	16

Safety Precautions

WARNING

TO REDUCE THE RISK OF FIRE, ELECTRICAL SHOCK, OR INJURY WHEN USING YOUR APPLIANCE, FOLLOW THESE BASIC PRECAUTIONS:

- Read all instructions before using the appliance.
- Never clean appliance parts with flammable fluids. The fumes can create a fire hazard. Do not use an excessively wet cloth, industrial solvents, and oil-based products to clean this appliance.
- To clean the convertible refrigerator/deep freezer, use only mild detergents. Never use harsh chemicals or solvents.
- Do not store or use gasoline or any other flammable vapors and liquids in the vicinity of this or any other appliance. The fumes can create a fire hazard.
- Do not abuse, sit on, or stand on the appliance.
- This appliance is not intended for use by persons (including children with reduced physical, sensory or mental capabilities, or lack of experience and knowledge, unless they have been given supervision or instruction concerning use of the appliance by a person responsible for their safety
- Children should be supervised to ensure that they do not play with the appliance.
- Ensure the convertible refrigerator/deep freezer is unplugged before cleaning or if not in use
- If the power cord is damaged, it must be replaced by the manufacturer or its service agent or a similarly qualified person in order to avoid a hazard.
- Use the convertible refrigerator/deep freezer only for its intended function. This appliance is designed for household, non-commercial use only. Any other use will void the warranty.
- Do not plug this convertible refrigerator/deep freezer into the power source before setup is completed.
- An empty convertible refrigerator/deep freezer can be dangerous for children and small animals. If disposing of the convertible refrigerator/deep freezer, remove gaskets, latches, and the entire convertible refrigerator/deep freezer door from your unused appliance so that children or small animals cannot be trapped inside.
- The convertible refrigerator/deep freezer is an electrical appliance. To avoid serious injury from electrical shock, do not operate the convertible refrigerator/deep freezer with wet hands, while standing on a wet surface, or while standing in water.
- To avoid the risk of shock, the product should never be used in bathrooms, shower rooms, or in any other steamy or wet areas.
- During installation, the power supply must not be excessively or dangerously bent or flattened.
- Do not tamper with controls.
- Make sure the power plug is placed fully and firm into the power source. If the wall receptacle you intend to use is not adequately grounded or protected by a time delay fuse or circuit breaker, have a qualified electrician install an outlet that is appropriate to local electrical codes and requirements.
- Do not use multiple socket or an extension cord as it may overheat and become a risk of fire. Please ensure that the convertible refrigerator/deep freezer is plugged directly into the electrical outlet.
- The cord should be secured behind the unit and should not be left exposed or dangling
- Make sure the power plug is clean before usage.
- Make sure hands are dry when connecting the power plug. The appliance is equipped with a three-prong grounded plug on the power cord for your protection. Never modify, remove or attempt to repair the power plug yourself.
- Never pull the power cord to disconnect the unit from an outlet. Grasp the plug directly and pull it from the outlet.
- Never lift or carry the convertible refrigerator/deep freezer by the power cord.
- Keep the power cord away from heated surfaces.
- Do not repair, disassemble and/or modify the appliance by yourself.
- Always turn off the appliance when cleaning or transporting.

Safety Precautions

- Transport the appliance in an upright position only.
- Always place the appliance on even and hard and level surface.
- Close the freezer door immediately after putting in any items to maintain the internal temperature of the unit.
- Avoid placing the freezer near external heat sources or direct sunlight.
- Make sure the freezer is placed on a flat, level, and solid surface.
- Place your appliance on a hard and level floor that is strong enough to support it when it is fully loaded.
- Do not turn the freezer upside down, on its side, or 45° or more off level.
- Keep fingers out of the “pinch point” areas; clearances between the doors and between the doors and cabinet are necessarily small. Be careful closing doors when children are in the area
- Do not touch the cold surfaces in the freezer compartment when hands are damp or wet, skin may stick to these extremely cold surfaces
- Do not move this freezer without securing the door in a closed and latched position.
- Do not refreeze frozen foods which have thawed completely
- Performance may vary based on operational and ambient conditions.

ELECTRICAL CONNECTION

The power cord of this appliance is equipped with a 3-prong (grounding) plug which mates with a standard 3-prong (grounding) wall outlet to minimize the possibility of electric shock hazard from this appliance. Have the wall outlet and circuit checked by a qualified electrician to make sure the outlet is properly grounded. Where a standard 2-prong wall outlet is encountered, it is your personal responsibility and obligation to have it replaced with a properly grounded 3-prong wall outlet. Do not use an adapter. The freezer should always be plugged into its own individual electrical outlet which has a voltage rating that matches the rating plate.

A 115 Volt AC, 60 Hz, 15- or 20-amp fused, grounded electrical supply is required. This provides the best performance and also prevents overloading house wiring circuits which could cause a fire hazard from overheated wires. Never unplug your freezer by pulling on the power cord. Always grip plug firmly and pull straight out from the outlet. Repair or replace immediately all power cords that have become frayed or otherwise damaged. Do not use a cord that shows cracks or abrasion damage along its length or at either end. When moving the freezer away from the wall, be careful not to roll over or damage the power cord

EXTENSION CORD

Because of potential safety hazards, it is strongly recommended that you do not use an extension cord with this appliance. However, if you must use an extension cord, it is absolutely necessary that it be a UL/CUL-Listed, 3-wire grounding type appliance extension cord having a grounding type plug and outlet and that the electrical rating of the cord be 15 amperes and 115 volts. Failure to follow these instructions can result in fire, electric shock, or death.

THE MANUFACTURER DISCLAIMS ANY RESPONSIBILITY IF THE ABOVE INSTRUCTIONS ARE NOT FOLLOWED.

Parts and Accessories



BOTTOM REAR SECTION

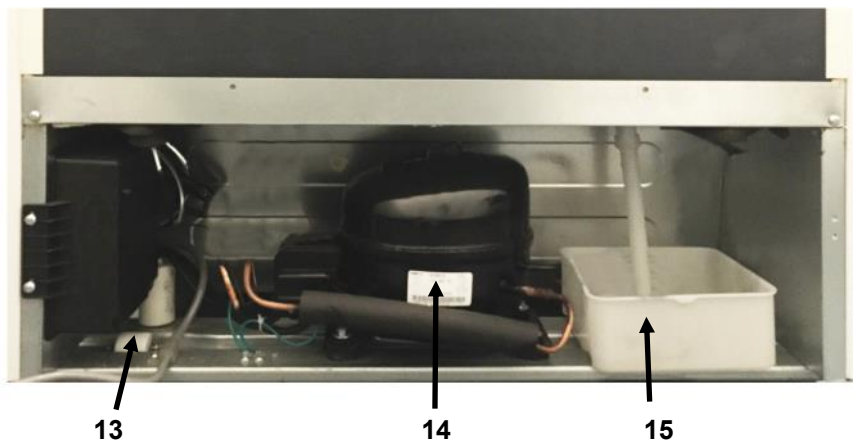

1. Door Handle	5. Leveling Leg	9. Air Outlet	13. Wheel Rollers (2)
2. Control Panel	6. Door Light Switch	10. Temperature Sensor	14. Compressor
3. Door Hinge Cover	7. Light	11. Slide-out Wire Basket (1)	15. Drip Tray
4. Leveling Leg	8. Sliding Cabinet Shelves (4)	12. Removable Door Rack Shelves (4)	

Product Features / Technical Data

Get the storage space and features you need with the stainless steel Whynter 13.8 cu.ft. Energy Star Digital Upright Convertible Deep Freezer / Refrigerator. With its powerful fan-circulated compressor, it ensures the precise airflow for efficient temperature distribution. Additionally, the convenient frost-free design ends the need to manually defrost this convertible refrigerator/deep freezer.

- Stainless steel door with a textured steel exterior
- Operates as a refrigerator or freezer
- Powerful compressor cooling
- “Quick Freeze” mode rapidly cools to -11°F
- Electronic temperature control - easy temperature management, with an LED display that can read in Celsius or Fahrenheit
- Frost-Free - saves you maintenance by preventing icy buildup and never have to empty the contents to manually defrost
- Soft interior lighting - offers an attractive yet energy efficient look inside
- Wheel rollers - lets you easily transport or move your freezer whenever the need arises
- 4 sliding cabinet shelves and 1 sliding bulk storage basket - offers versatility and flexibility to organize your favorite foods for quick and easy access
- 4 removable freezer door rack shelves - for quick access and easy selection
- Audible alarms - for high temperature fluctuations and open door alerts
- Temperature memory function - memorizes desired temperature setting for consistent results
- Freestanding setup (clearance around the unit is needed)

TECHNICAL DATA

MODEL :	UDF-139SS
Storage Volume	13.8 cu. ft.
Temperature Control Range	Freezer mode : -11°F - 10°F (-23°C - -12°C) Refrigerator mode : 35°F - 46°F (2°C - 8°C)
Net Weight	149 lbs
Gross Weight	165 lbs
Unit Dimensions	28" W x 30" D x 62" H
Packaging Dimensions	30" W x 32" D x 65" H
Refrigerant	R600A
Noise Level	≤45dB
Certification	UL Certified and Energy Star rated
UPC	852749006665

Installation



Excessive Weight Hazard

Two or more people should move and install convertible refrigerator/deep freezer. Failure to do so can result in back or other injury.

REMOVE PACKAGING MATERIALS

IMPORTANT: Do not remove any permanent instruction labels or the data label on your convertible refrigerator/deep freezer

REMOVE TAPE AND GLUE FROM YOUR UPRIGHT FREEZER BEFORE USING

- To remove any remaining tape or glue, rub the area briskly with your thumb. Tape or glue residue can also be easily removed by rubbing a small amount of liquid dish soap over the adhesive with your fingers. Wipe with warm water and dry.
- Do not use sharp instruments, rubbing alcohol, flammable fluids, or abrasive cleaners to remove tape or glue. These products can damage the surface of your convertible refrigerator/deep freezer.

CLEANING BEFORE USE

- After you remove all of the packaging materials, clean the inside of your convertible refrigerator/deep freezer before using it.

INSTALLATION CLEARANCES

Your convertible refrigerator/deep freezer should be conveniently located for day-to-day use in a dry, well-ventilated room. Do not install the convertible refrigerator/deep freezer where the temperature will go below 50°F or above 90°F, because it will not maintain proper temperatures. Be sure to install your convertible refrigerator/deep freezer on a floor strong enough to support it when it is fully loaded.

FREESTANDING INSTALLATION

A freestanding installation will allow you to install the convertible refrigerator/deep freezer in any place you desire provided that the required clearance space around the appliance is respected. In every setting, there must be adequate ventilation and access for service. Never install or operate the unit in an enclosed area, such as a closed cabinet.

- Before connecting the convertible refrigerator/deep freezer to the power source, let it stand upright for approximately 4 hours. This will reduce the possibility of a malfunction in the cooling system from handling during transportation.
- The normal operation of the convertible refrigerator/deep freezer depends on heat radiation from the condenser. Allow at least 6 inches of space between the back and sides of the appliance, which allows the proper air circulation to cool the compressor and condenser. The installation should allow the convertible refrigerator/deep freezer to be pulled forward for servicing if necessary.
- This unit **MUST** be installed in an area protected from the elements, e.g., wind, rain, water spray or drips. Do **NOT** use the convertible refrigerator/deep freezer in outdoor setting.
- The convertible refrigerator/deep freezer should not be located next to ovens, grills or other high heat resources.
- Too much humidity in the air will cause frost to form quickly on the evaporator requiring more frequent defrosting of the convertible refrigerator/deep freezer.
- Avoid locating the appliance in area that may be exposed to excessive moisture.
- The convertible refrigerator/deep freezer must be installed with all electrical requirements followed.
- The unit should be located on a hard and level surface that can support the unit when it is full. It is important for the convertible refrigerator/deep freezer to be level in order to work properly. If needed, you can adjust the height of the convertible refrigerator/deep freezer by turning the feet. See the “Leveling the Upright Freezer” section.

Installation

- A standard electrical supply (115 VAC only, 60 Hz, 10A), properly grounded in accordance with National Electrical Code and local codes and ordinances is required.
- **IMPORTANT:** Do not kink or pinch the power supply cord between the convertible refrigerator/deep freezer and wall or cabinet.

PLACEMENT OF YOUR APPLIANCE

- Position the convertible refrigerator/deep freezer in a dry and well-ventilated place. Keep the convertible refrigerator/deep freezer away from direct sunlight, heaters, and corrosive gases or chemicals.
- Clean the interior surface with lukewarm water using a soft cloth.
- Place your appliance on a hard and level floor that is strong enough to support it when it is fully loaded.
- The convertible refrigerator/deep freezer can be easily moved from one room to another by using the pre-installed wheel rollers.
If the appliance is needed to be lifted, two or more people should move convertible refrigerator/deep freezer. Failure to do so can result in back or other injury.
- We do not recommend installing the appliance on carpet.

DOOR INSTALLATION

This appliance includes a door handle that is not required for operation. To install the handle, please follow the instructions below:

1. Install the two screws onto the door holes as shown. Make sure that the screws are securely installed.
2. Carefully line up the door handle to the installed screws.
3. Secure the door handle in place by tightening the pre-installed recessed screws using the wrench provided.

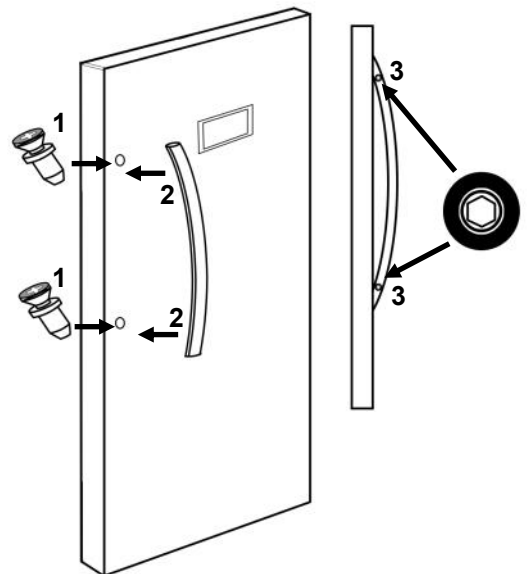

LEVELING THE UPRIGHT FREEZER

It is important for the convertible refrigerator/deep freezer to be leveled in order to work properly. It can be raised or lowered by turning the two feet on the bottom of the machine. If the convertible refrigerator/deep freezer is not leveled during installation. The doors may not close or seal properly, causing cooling, frost, or moisture problems. It is very important that the convertible refrigerator/deep freezer is at level in order to function properly.

NOTE: This convertible refrigerator/deep freezer comes with 2 leveling legs and 2 wheel rollers

We recommend using a carpenter's level to check the machine.

1. Place a carpenter's level on top of the product to see if the convertible refrigerator/deep freezer is level from front to back and side to side.
2. Adjust the height of the feet as follows:
 - Turn the leveling feet to the right to lower that side of the convertible refrigerator/deep freezer
 - Turn the leveling feet to the left to raise that side of the convertible refrigerator/deep freezer

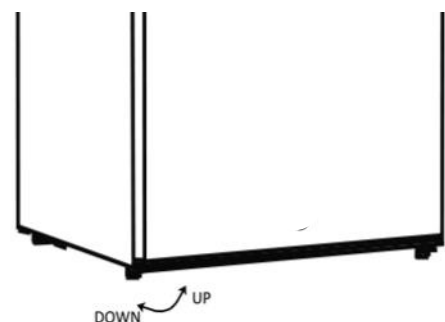







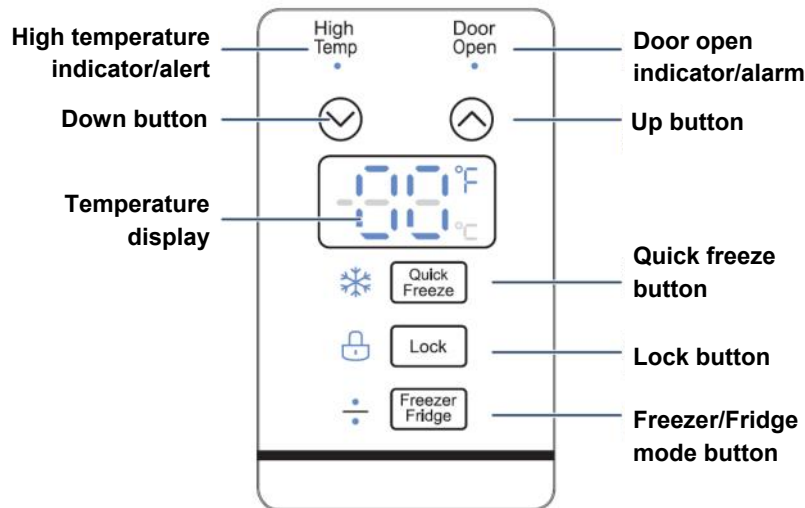

Operation and Controls

CONTROL PANEL GUIDE

To obtain the best possible results for your convertible refrigerator/deep freezer, it is important that you operate it properly. Your convertible refrigerator/deep freezer uses an electronic digital control system for adjusting the thermostat.



- 1. Up Button** 
Press the Up button to increase the set temperature by 1°C or 1°F
- 2. Down Button** 
Press the Down button to decrease the set temperature by 1°C or 1°F
- 3. Quick Freeze Button**  
Quick Freeze enables the compressor to run continuously to help cool large quantities of warm (room temperature) foods faster.
Press and hold the 'LOCK' button for three seconds to unlock the control panel. Press the Quick Freeze button to run on this mode. The Quick Freeze mode will then cancel automatically after 24 hours has elapsed. To manually cancel, while in Quick Freeze mode, press the 'LOCK' button to unlock the control panel and press the Quick Freeze button.
Note: For energy saving purposes, we recommend to run the Quick Freeze with a total duration time of 6 hours
- 4. Lock Button**  
The convertible refrigerator/deep freezer locks automatically the control panel after 30 seconds if buttons are not pressed. To deactivate the control lockout, press and hold the 'LOCK' button for three seconds and an audible chime will be heard confirming that the control lockout is deactivated.
NOTE: Opening the convertible refrigerator/deep freezer door does not deactivate the control lockout.
- 5. Freezer/Refrigerator Button**  
This convertible refrigerator/deep freezer has an advanced design feature that lets you change it from a freezer to a refrigerator and vice-versa. Freezer/Refrigerator light on the control panel indicates the current mode. Press and hold convertible refrigerator / deep freezer for three seconds to unlock the control panel. Press and hold the Freezer/Refrigerator button for three seconds to change modes. The panel beeps and the indicator changes to the new mode.
- 6. Temperature Indicator**
Temperature display can be changed from °F to °C or °C to °F. Press and hold LOCK for three seconds to unlock the control panel. Press and hold the Up and Down buttons for three seconds. Press and hold the Up and Down buttons again to change it back to the previous temperature conversion.
- 7. Hi-Temp Indicator / Hi-Temp Alarm**
If the internal temperature rises to a level above 18°F (-8°C) in Freezer mode and 59°F (15°C) in Refrigerator mode, the "Hi-Temp" display indicator will illuminate and the control panel will start beeping. You may stop the beeping by pressing any button. The "Hi-Temp" display indicator will continue to be illuminated until the problem is determined, corrected and temperature once again drops to a level below 11°F (-12°C).
NOTE: Make sure to close the door properly as outside air may cause temperature inside the freezer cabinet to rise.
- 8. Door Open Indicator / Door Open Alarm**
The audible door alarm will activate and the "Door Open" indicator will illuminate if the door is open for more than five minutes. Close the door to turn the audible alarm and the "Door Open" indicator off.

Operation and Controls

DISPLAY SCREEN

- The display screen shows the temperature level from -11° to 10°F (-24° to -12°C) in Freezer Mode and 35°F to 46°F (2° to 8°C) in Refrigerator Mode.
- After setting the desired temperature, the set temperature will stay on for about 30 seconds then it will disappear.
- The display screen will show the current set temperature every time the door is opened.

TEMPERATURE MEMORY FUNCTION

In the event of a power interruption (power surge, breaker switch, etc.), the convertible refrigerator/deep freezer restarts at the previously set function mode and settings when power is restored.

NOTE: If the appliance is unplugged, encounter power interruption, or turned off, you must wait 3 -5 minutes before restarting the appliance. If attempted to restart before this time delay, the appliance may not start.

TEMPERATURE OUT OF RANGE ALARM

Refrigerator Mode

If the internal temperature is at least 59°F (15°C) different than the set temperature 36 hours after closing the door, an audible alarm will activate for 10 seconds for every two minutes. This audible alarm sequence will continuously run until it is deactivated.

Freezer Mode

If the internal temperature is at least 18°F (-8°C) different than the set temperature 36 hours after closing the door, an audible alarm will activate for 10 seconds for every two minutes. This audible alarm sequence will continuously run until it is deactivated.

The alarm can be deactivated by pressing any button on the control panel.

Some possible causes are:

- Ambient room temperature is too warm or cold. Adjust the room's temperature.
- The ventilation openings are blocked or dusty. Make sure to remove any obstructions.
- There is too much frost build up. Defrost the convertible refrigerator/deep freezer.
- There are door seal gaps. Make sure that the door is properly closed and door seals are not cracked or broken.

FREEZER LIGHT

This convertible refrigerator/deep freezer comes equipped with energy saving light, which helps in lighting up the interior effectively. This convertible refrigerator/deep freezer light comes on automatically when the convertible refrigerator/deep freezer door is opened. The convertible refrigerator/deep freezer light will shut off once the convertible refrigerator/deep freezer door is completely closed.

NORMAL SOUNDS

Your new convertible refrigerator/deep freezer may make sounds that are not familiar to you. Hard surfaces like the floor, walls can make the sounds seem louder than they actually are. The following describes the kinds of sounds that might be new to you and what may be making them.

- Rattling noises may come from the flow of the refrigerant or the water line, items stored on top of the convertible refrigerator/deep freezer can also make noises.
- The surface temperature of the compressor can reach $158 - 194^{\circ}\text{F}$ when running.
- The high efficiency compressor may make a pulsating or high-pitched sound.
- The noise emitted by the cooling fan on the condenser is a normal function.
- It is normal for the fan in the power supply to run all the time.
- As each cycle ends, you may hear a gurgling sound due to the refrigerant flowing in your convertible refrigerator/deep freezer.

STORING FROZEN FOOD

For safe food storage, allow 4 hours for the convertible refrigerator/deep freezer to cool down completely. The convertible refrigerator/deep freezer will run continuously for the first several hours. Foods that are already frozen may be placed in the convertible refrigerator/deep freezer after the first few hours of operation.

- Unfrozen food should NOT be placed until it has operated for 4 hours. Allow several hours after each one-step adjustment for the temperature to stabilize.

Operation and Controls

- When loading, freeze only 3 pounds of fresh food per cubic foot of space at a time. Distribute packages evenly throughout the cabinet.
- Storage recommendation printed on the packaging of frozen food by the manufacturers should be always be followed.

FREEZING FRESH FOOD

Ensure that your freezing operations are carried out under the most hygienic conditions as freezing alone does not sterilize the food.

- It is advisable to freeze the food by packing it into separate meal portions and not in bulk form. Never put hot or warm food stuffs into the convertible refrigerator/deep freezer.
- Prior to storing the frozen food, pack it in plastic bags, aluminum sheets or freezing containers and place into the convertible refrigerator/deep freezer.
- Fresh foods should not be stored together with frozen foods.
- When the temperature is set below 32°F, do not keep glass-bottled drinks such as beer and lemonade or soda cans, as the glass and cans might shatter.
- Do not use this deep freezer as a refrigerator when the ambient temperature is below 41°F as food can become frozen.

Note: For best performance, leave enough space inside the convertible refrigerator/deep freezer cabinet for air to circulate around the packages.

Cleaning and Maintenance

NO DEFROSTING

You never have to defrost your convertible refrigerator/deep freezer. It has been preset at the factory to defrost itself automatically. During defrosting, a slight noise may be noticed if the door is opened while the convertible refrigerator/deep freezer is in the automatic defrosting cycle.

CLEANING

Outside/Exterior

- Wipe with a clean cloth lightly dampened with appliance polish wax or mild liquid dishwashing detergent. Dry and polish with a clean, soft cloth.
- Do not wipe the convertible refrigerator/deep freezer with a soiled dishwashing cloth or wet towel. Do not use scouring pads, powdered cleaners, bleach, or cleaners containing bleach.

Inside

- Use warm water and baking soda solution—about a tablespoon of baking soda to a quart of water. Rinse thoroughly with water and wipe dry.
- Do not use cleaning powders or other abrasive cleaners. An open box of baking soda in the convertible refrigerator/deep freezer will absorb stale freezer odors. Change the box every three months.
- An open box of baking soda in the convertible refrigerator/deep freezer will absorb stale odors. Change the box every three months.

CHANGING THE LIGHT BULBS

To change the light bulb, make sure to unplug freezer or disconnect unit from power supply before removing the bulb. Replace the bulb with a 40-watt appliance bulb. Please note that not all bulbs will fit your freezer. Be sure to replace the bulb with one of the same size and shape. Plug in the freezer or reconnect freezer to power supply after bulb replacement.

PROLONGED OFF PERIODS

If the convertible refrigerator/deep freezer is not to be used for a long period of time, disconnect convertible refrigerator/deep freezer from main power supply. Clean and dry the inside as instructed. Leave the convertible refrigerator/deep freezer door open to prevent any mold and mildew growth.

Usage Tips:

- Keep the convertible refrigerator/deep freezer's door closed as much as possible. Try not to open the door too frequently, especially when weather is hot and humid
- Ensure that the unit has sufficient clearance for ventilation
- For normal household use, it is recommended to set the thermostat in the middle setting.
- Before loading the convertible refrigerator/deep freezer with an item, make sure they are cooled to ambient temperature.
- Ice and frost layer increase energy consumption, defrost when frost is 3-5 mm thick.

PREPARING FOR VACATION

To maintain convertible refrigerator/deep freezer in operation during vacations, be sure your house power is not turned off. For extended vacations or absences, you may prefer to move your frozen foods to a storage locker temporarily. If your convertible refrigerator/deep freezer is to be left empty, disconnect power cord plug from power source. To prevent formation of odors, place open box of baking soda in convertible refrigerator/deep freezer and leave convertible refrigerator/deep freezer door open.

IN CASE OF EXTENDED POWER FAILURE

- Keep convertible refrigerator/deep freezer door closed. This will keep food frozen or refrigerated for up to 24 hours provided warm air is not admitted.
- If convertible refrigerator/deep freezer is out of operation for 24 hours or more, add dry ice. Leave ice in large pieces. Add more ice as required.
- If dry ice is not available, move food to frozen locker temporarily—until power is restored

NOTE: Handling of dry ice can cause freezing of the hands—gloves or other protection is recommended.

Cleaning and Maintenance

ENERGY SAVING TIPS

The convertible refrigerator/deep freezer should be located in the coolest area of the room, away from heat-producing appliances or heating ducts, and out of direct sunlight. Let hot foods cool to room temperature before placing in the convertible refrigerator/deep freezer. Overloading the convertible refrigerator/deep freezer forces the compressor to run longer. Foods that freeze too slowly may lose quality or spoil. Be sure to wrap foods properly, and wipe containers dry before placing them in the convertible refrigerator/deep freezer. This cuts down on frost buildup inside the convertible refrigerator/deep freezer.

Freezer shelves should not be lined with aluminum foil, wax paper or paper toweling. Liners interfere with cold air circulation, making the convertible refrigerator/deep freezer less efficient. Organize and label food to reduce door openings and extended searches. Remove as many items as needed at one time, and close the door as soon as possible.

Troubleshooting

Many common convertible refrigerator/deep freezer problems are easily resolved. Try the troubleshooting suggestions below to see if the problems can be resolved before having to contact the service department.

Problem	Possible Causes	Solutions
The machine won't operate	<ul style="list-style-type: none"> • The convertible refrigerator/deep freezer is unplugged • The voltage is not in the correct range • Too many appliances running form the same power circuit 	<ul style="list-style-type: none"> • Push the plug completely into the power source • Make sure that the convertible refrigerator/deep freezer runs on a dedicated power source that can support the maximum power consumption of the convertible refrigerator/deep freezer • Run the convertible refrigerator/deep freezer on a dedicated power source
Noise during operation	<ul style="list-style-type: none"> • The legs are not leveled • Certain sounds are normal 	<ul style="list-style-type: none"> • Make sure legs are properly installed • See "Normal Sounds"
The compressor runs for 1 to 5 minutes and stops	<ul style="list-style-type: none"> • The voltage is not in the correct range 	<ul style="list-style-type: none"> • Unplug and restart when the power is normal
The compressor runs but the inner liner does not get very cold	<ul style="list-style-type: none"> • The ambient temperature is too high • The system is blocked 	<ul style="list-style-type: none"> • If temperature is higher than 90°F, the unit need longer to cool to the set temperature • Contact Whynter Service Department via email at service@whynter.com
The convertible refrigerator/deep freezer does not cool sufficiently	<ul style="list-style-type: none"> • Freezer door being opened frequently • Freezer door left open for a while • Not enough adequate clearance • Freezer is overfilled • Ambient temperature is too high 	<ul style="list-style-type: none"> • Refrain from opening the convertible refrigerator/deep freezer door recurrently • Make sure to close convertible refrigerator/deep freezer door • Follow recommended clearance measurements • If temperature is higher than 90°F, the unit need longer to cool to the set temperature
The compressor does not run	<ul style="list-style-type: none"> • The controller is faulty (the power indicator is not on) • The thermostat is set too high and the ambient temperature is too low 	<ul style="list-style-type: none"> • Contact Whynter Service Department via email at service@whynter.com • Set the convertible refrigerator/deep freezer to a lower temperature
Interior light does not work	<ul style="list-style-type: none"> • No power at outlet • Freezer is unplugged • Light bulb burned out 	<ul style="list-style-type: none"> • Replace fuse or reset the breaker • Push the plug completely into the outlet • Replace light bulb
Door does not fully close	<ul style="list-style-type: none"> • Legs are not properly leveled • Stored items holding door open 	<ul style="list-style-type: none"> • See "LEVELING THE UPRIGHT FREEZER" • Move stored item to a different location
Foods defrosting	<ul style="list-style-type: none"> • Freezer is unplugged • Fuse blown • Freezer door being opened frequently 	<ul style="list-style-type: none"> • Push the plug completely into the power source • Replace fuse or reset the breaker • Check to see if an object is holding the door open
Excessive frost buildup	<ul style="list-style-type: none"> • Door left open too frequent or too long door openings • High humidity 	<ul style="list-style-type: none"> • Check to see if an object is holding the door open • Open the door less often

Troubleshooting

Many common convertible refrigerator/deep freezer problems are easily resolved. Try the troubleshooting suggestions below to see if the problems can be resolved before having to contact the service department.

Problem	Possible Causes	Solutions
Freezer external surface is warm	<ul style="list-style-type: none"> The external convertible refrigerator/deep freezer walls can be as much as 30°F warmer 	<ul style="list-style-type: none"> This is normal while the compressor works to transfer heat from inside the convertible refrigerator/deep freezer cabinet
Moisture forms on inside convertible refrigerator/deep freezer walls	<ul style="list-style-type: none"> Weather is hot and humid, which increases internal rate of frost buildup Door may not be seating properly Door is kept open too long, or is opened too frequently 	<ul style="list-style-type: none"> This is normal Check door installation Open the door less often
Odors in convertible refrigerator/deep freezer	<ul style="list-style-type: none"> Interior needs to be cleaned Food with strong odors are in the convertible refrigerator/deep freezer 	<ul style="list-style-type: none"> Clean interior with sponge, warm water, and baking soda

ALARM FUNCTION TABLE

Display Status	Function	Response
Internal temperature setting is displayed	<ul style="list-style-type: none"> Normal Operation 	<ul style="list-style-type: none"> None
Alternating "E" and "7", "8" or "9"	<ul style="list-style-type: none"> High temperature inside the freezer cabinet Operational error 	<ul style="list-style-type: none"> Make sure door is properly closed Contact Whynter Service Department via email at service@whynter.com
Control panel beeps. "Hi-Temp" is lit	<ul style="list-style-type: none"> Internal temperature is too high 	<ul style="list-style-type: none"> Contact Whynter Service Department via email at service@whynter.com Press any button mute audible alarm
Control panel beeps. "Door Open" is lit	<ul style="list-style-type: none"> Door Open 	<ul style="list-style-type: none"> Close freezer door
Display Off	<ul style="list-style-type: none"> Once the desired temperature level is set, the set temperature will stay on for about 30 seconds then it will disappear. Power failure 	<ul style="list-style-type: none"> None Reconnect power supply Contact Whynter Service Department via email at service@whynter.com

ONE YEAR LIMITED WARRANTY

This Whynter product is warranted, to the original owner within the 48 continental states, for one year from the date of purchase against defects in material and workmanship under normal use and service. When making a warranty claim, please have the original bill or invoice of purchase with purchase date available. Should your Whynter product prove defective within one year from the date of purchase, return the defective part or unit, freight prepaid (within two months of purchase; after two months to one year, customer will be responsible for freight cost to Whynter's service department), along with an explanation of the claim to Whynter LLC. A return authorization number issued by Whynter is required for all warranty claims and returns. Please package the Whynter product carefully in its original packaging material to avoid damage in transit. The original box and packaging material should be retained, as Whynter is not responsible for the cost of replacement packaging. Under this warranty, Whynter will repair or replace any parts found defective at our discretion. This warranty is not transferable. After the expiration of the warranty, the cost of labor and parts will be the responsibility of the original owner of the unit.

THIS WARRANTY DOES NOT COVER:

- Acts of God, such as fire, flood, hurricanes, earthquakes and tornadoes.
- Improper power supply such as power surge, low voltage, defective household wiring or inadequate fuses.
- Use in commercial or industrial applications
- Damage, accidental or otherwise, to the product while in the possession of a consumer not caused by a defect in material or workmanship;
- Damage caused by consumer misuse, tampering, or failure to follow the care and special handling provisions in the instructions.
- Damage to the finish of the case, or other appearance parts caused by wear.
- Damage caused by repairs or alterations to the product by anyone other than authorized by the manufacturer.
- Removal, Replacement Packaging, Freight and Insurance cost for the warranty service.

DISCLAIMER OF IMPLIED WARRANTIES; LIMITATION OF REMEDIES CUSTOMER'S SOLE AND EXCLUSIVE REMEDY UNDER THIS LIMITED WARRANTY SHALL BE PRODUCT REPAIR OR REPLACEMENT AS PROVIDED HEREIN. CLAIMS BASED ON IMPLIED WARRANTIES, INCLUDING WARRANTIES OF MERCHANTABILITY OR FITNESS FOR A PARTICULAR PURPOSE, ARE LIMITED TO ONE YEAR OR THE SHORTEST PERIOD ALLOWED BY LAW, BUT NOT LESS THAN ONE YEAR. WHYNTER SHALL NOT BE LIABLE FOR CONSEQUENTIAL OR INCIDENTAL DAMAGES SUCH AS PROPERTY DAMAGE AND INCIDENTAL EXPENSES RESULTING FROM ANY BREACH OF THIS WRITTEN LIMITED WARRANTY OR ANY IMPLIED WARRANTY. SOME STATES AND PROVINCES DO NOT ALLOW THE EXCLUSION OR LIMITATION OF INCIDENTAL OR CONSEQUENTIAL DAMAGES, OR LIMITATIONS ON THE DURATION OF IMPLIED WARRANTIES, SO THESE LIMITATIONS OR EXCLUSIONS MAY NOT APPLY TO YOU. THIS WRITTEN WARRANTY GIVES YOU SPECIFIC LEGAL RIGHTS. YOU MAY ALSO HAVE OTHER RIGHTS THAT VARY FROM STATE TO STATE.

**Please retain the original proof of purchase in order to obtain warranty services.
Warranty begins from the original date of purchase.**

To obtain service or information, contact
Whynter LLC via email at support@whynter.com or call
866-WHYNTER.

Product contents and specifications may change without notice.

Copyright © 2018 Whynter LLC
WWW.WHYNTER.COM

V 2018.2.9-1547